

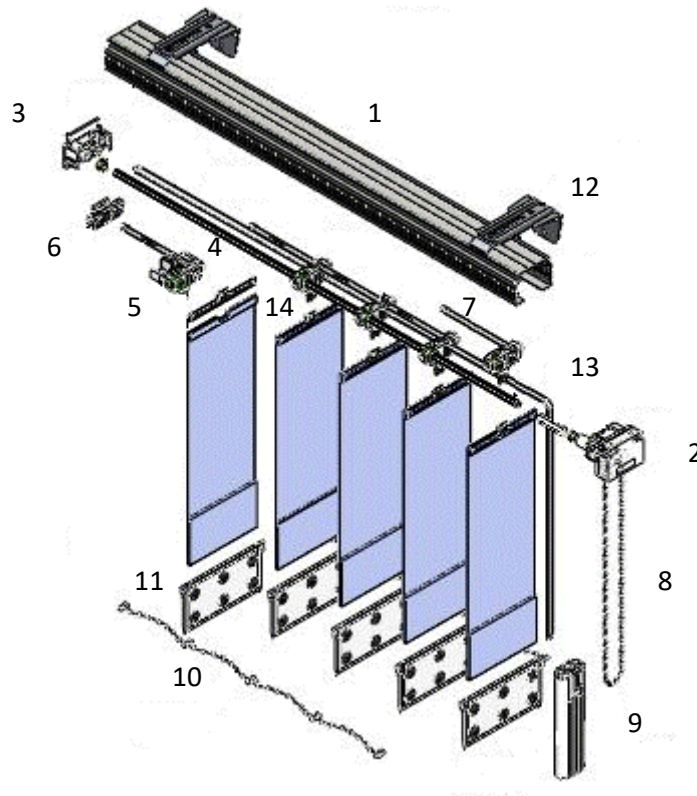

Vertical

Vertical Standard

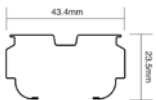





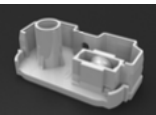

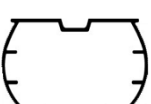



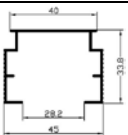







1 	PERFIL AÇO WHITE OVAL. P/ PV	009.026.000.00.07	Trilho em Aço	6 m
---	-------------------------------------	-------------------	---------------	-----

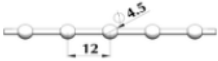
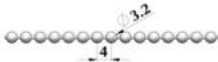





2 	REDUTOR S/ CALOTA P/ PERFIL AÇO OVAL. 10	100.006.011.00.23	Perf Aço.	100 unid
Usar com: Corrente Bola 6 Simples				

3 	PONTA OPOSTA P/ PERFIL AÇO OVAL	100.007.001.00.23	Perf Aço.	100 unid
Usar com: Perfil Aço				

1 	PERFIL SUP. ALUM. OVAL. FRIS. CRUDE P/ PV	008.026.000.00.00	Ovalado Frisado	6 m
---	--	-------------------	-----------------	-----

2		REDUTOR OVAL. C/ CALOTA P/ BOLA 10 SIMPLES PV	100.006.012.00.23	Perf Oval.	100 unid	Usar com: Corrente Bola 10 Simples
3		PONTA OPOSTA P/ PV	100.007.000.00.23	Perf Oval.	100 unid	Usar com: Perfil Ovalado
1		PERFIL SUP. ALUM. QUAD. FRIS. CRUDE P/ PV	008.015.002.00.00	Quadrado	6 m	
2		REDUTOR P/ PERFIL QUAD. 10	100.006.003.00.24	Perf Quadrado	100 unid	Usar com: Corrente Bola 10 Simples
3		PONTA OPOSTA P/ PV	100.126.000.00.24	Perf Quadrado	100 unid	Usar com: Perfil Quadrado
4		EIXO ALUM. 4 FRISOS P/ PV	008.100.002.00.00	Eixo 4 Frisos	5,8 m	
4		EIXO ALUM. 3 FRISOS P/ PV	008.100.001.00.00	Eixo 4 Frisos	5,8 m	
5		CARRO PLAST. PIAO TRANSP. P/ PV	100.001.001.00.23	Carrinho Pião	500 unid	Usar com: EIXO ALUM. CRU 4 FRISOS P/ PV
6		CARRO PLAST. TRANSPORTADOR P/ PV	100.001.006.00.23	Transportador	100 unid	Usar com: Perfil Ovalado
7		ESPAÇADOR PVC ADVANCED 75mm P/ PV	100.075.005.00.23	Transportador	100 unid	Usar com: CARRO PIAO CRISTAL ADVANCE

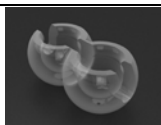
8		CORRENTE PVC RDO. SIMPLES 10 4,50x12mm	014.002.COR.10.66	WHITE/Bege/Cinza	180 m	Usar com: REDUTOR P/ PERFIL OVAL. 10
8		CORRENTE PVC RDO. DUPLA 6 3,20x4mm	014.003.COR.06.66	WHITE/Bege/Cinza	180 m	Usar com: REDUTOR P/ PERFIL OVAL. 10
9		PENDULO C/ PESO P/ PV	100.125.COR.00.23	WHITE/Bege/Cinza	100 unid	Usar com: Corda Trançada
9		PENDULO TOP LUX C/ PESO WHITE 0,046g P/ PV	100.127.005.00.23	White	100 unid	Usar com: Corda Trançada
10		CORRENTE PVC BOLA C/ CLIP C 89mm 3.2X8.0mm	014.005.100.06.00	Beige	250 m	Usar com: Balastro
10		CORRENTE PVC BOLA C/ CLIP Y 89mm 3,2X8,0mm	014.011.COR.06.23	White/Bege/Cinza	250 m	Usar com: Balastro
10		CORRENTE BASE TOMBAK CADEADO 0.60mm	014.008.000.00.00	Base	200 m	Usar com: Envelope
10		CORRENTE INOX PINGO DA AGUA CRUDE 0.60mm	014.009.000.00.00	Base	200 m	Usar com: Envelope
11		BALASTRO 89mm 32g	100.004.005.00.23	Balastro	500 unid	

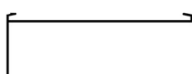
12		GARRA C/ TEMPERA 40mm P/ PV		
		100.016.005.00.00	White	500 unid
		100.016.000.00.00	Zincado	500 unid
		100.025.000.40.23	PVC	100 unid
Usar com: Perfil Ovalado				
13		CORDA TRANCADA 2,00mm		
		025.006.COR.20.00	Corda Trançada	500 m
14		CABIDE		
		100.090.005.09.23	89 mm	500 unid
		100.110.005.11.00	110 mm	500 unid
Usar com: CARRO PIAO CRISTAL ADVANCE				
15		CARRINHO LOUCO PLAST. P/ PV		
		100.001.007.00.23	Carrinho	100 m
Usar com: EIXO ALUM. CRU 4 FRISOS P/ PV				
16		CLIP PLAST. 10mm P/ ESPACADOR PV		
		100.118.000.00.23	Clip	500 unid
Usar com: ESPACADOR ADVANCED 75mm				
17		LIMITADOR CONECTOR PLAST. TRANSP. P/ CORRENTE		
		014.020.000.00.23	Plástico (PVC)	500 pc
Usar com: CORRENTE BOLA 10 DUPLA PLÁSTICO 4,5X6mm				
18		CONTA P/ CORDA		
		100.117.002.00.23	Pac-man	500 unid
19		ADAPTADOR PLAST. INCLINADO P/ PV		
		100.024.000.00.23	Adaptador	100 unid
Usar com: CARRO PIAO CRISTAL ADVANCE				
20		BANDO ALUM. WHITE P/ PV		
		008.102.005.00.00	Bando	6 m

22



CANTONEIRA RETA LATERAL P/ BANDO L

100.100.003.00.00

Reta

50 unid

Suportes e Alongadores

Suportes e Alongadores

	SUPORTE ALONGADO C/ ENCAIXE CRUDE 13cm P/ BANDO PH25/50	027.001.000.13.19		10 unid
	SUPORTE ALONGADO CRUDE 10cm P/ PH25	027.004.000.10.19		10 unid
	SUPORTE ALONGADO CRUDE 13cm P/ PH25	027.003.000.13.19		10 unid
	SUPORTE L WHITE 4.50x7mm UNIVERSAL	027.016.005.08.02		10 unid
	SUPORTE L 4.50x10mm UNIVERSAL	027.016.000.08.02	Crude	10 unid
		027.016.005.10.02	White	10 unid
	SUPORTE L C/ 10 FUIROS CRUDE 4x10mm P/ PH25/50	027.013.000.10.19		10 unid
	SUPORTE L C/ ENCAIXE CRUDE 4x10mm P/ BANDO PV	027.015.000.10.19		10 unid
	SUPORTE L C/ 6 FUIROS CRUDE 4x5mm P/ PH25/50	027.012.000.05.19		10 unid

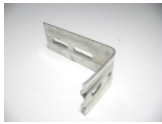

SUPORTE L CRUDE 4x8mm UNIVERSAL

027.016.000.08.19

10 unid



SUPORTE L CRUDE UNIVERSAL

A x P

027.006.000.10.13

8 x 10mm

10 unid

027.007.000.10.19

9 x 10mm

10 unid

027.008.000.15.19

9 x 15mm

10 unid

027.009.000.20.13

8 x 20mm

10 unid

027.010.000.25.19

9 x 25mm

10 unid

027.011.000.30.19

9 x 30mm

10 unid

