

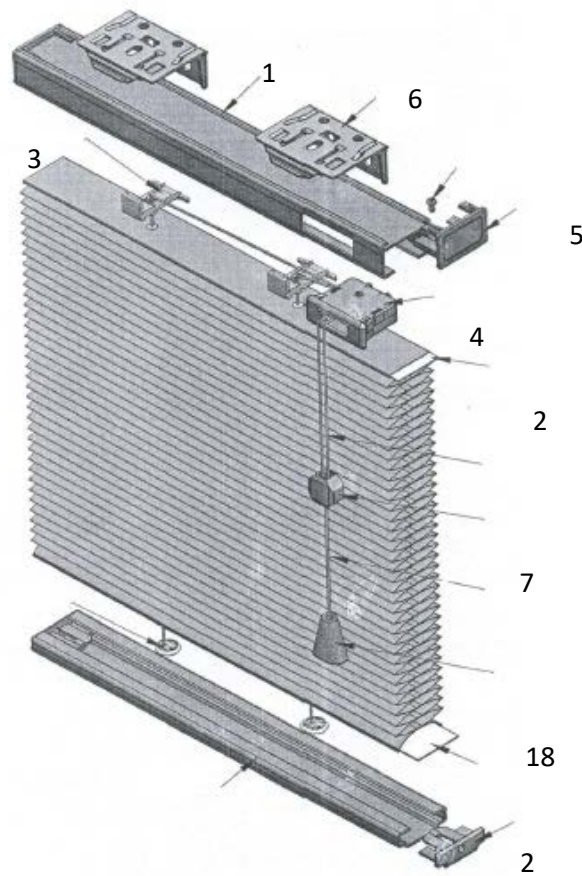

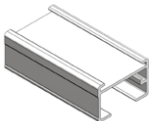





Sistema 5003 - Acionamento Corda

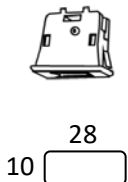
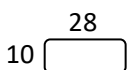
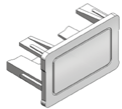

1		PERFIL SUP. ALUM. WHITE P/ 5003	008.058.005.00.09	Perfil Superior	5,8 m
2		REGUA 22.5mm P/ 5003 E 5004	101.059.000.00.02	Régua	150 m
Usar com: PERFIL SUP. ALUM. WHITE P/ CELULAR 5003 p/ prender o tecido					
3		GUIA DA CORDA PLAST. P/ 5003	105.021.000.00.02	Guia	100 unid
Usar com: PERFIL SUP. ALUM. WHITE P/ CELULAR 5003 25mm e Corda 0,9mm					
4		FREIO DA CORDA P/ CELULAR 5003	105.024.000.00.02	Direito	100 unid
			105.025.000.00.02	Esquerdo	100 unid
Usar com: PERFIL SUP. ALUM. WHITE P/ CELULAR 5003 25mm e Corda 0,9mm					

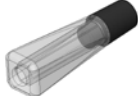
5		TAMPA PLAST. WHITE P/ PERFIL SUP. 5003	104.051.005.00.02	Tampa Sup.	100 unid	Usar com: PERFIL SUP. ALUM. WHITE P/ CELULAR 5003	
6		GARRA METAL CRUDE P/ 5003	027.023.000.00.02	Botão	1000 unid	Usar com: PERFIL SUP. ALUM. WHITE P/ CELULAR 5003	
7		LIMITADOR PLAST. P/ 5003	014.020.000.00.02	Limitador	1000 unid	Usar com: Corda 0,9mm	
8		PINGENTE ALUM. 35mm P/ PHM	104.004.COR.00.84	Alumínio	10 unid	Usar com: Corda 1,2mm	
8		PINGENTE CORDA INCOLOR TAMPA BRANCA	101.054.000.00.23	Pingente	100 unid	Usar com: Corda 1,2mm	
		ENROLADOR DA CORDA P/ 5003	115.002.000.00.02	Enrolador	1000 unid	Usar com: Corda 0,9mm	
		PARAFUSO P/ 5003	029.032.000.00.02	2.3mm X 6.5mm	1 unid	P/ Perfil Superior	
			029.033.000.00.02	3mm X 21mm	1 unid	P/ Enrolador da Corda	
			029.034.000.00.02	3,4mm X 32,5mm	1 unid	P/ Garra Zinc	
PERFIL INFERIOR (BASE) – Ver opções na página nº 128							
CORDAS E ACESSÓRIOS – Ver opções na página nº 129							
FERRAMENTAL PARA PRODUÇÃO – Ver opções na página nº 129							

Perfil Inferior (Base)

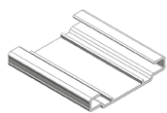

PERFIL INF. ALUM. WHITE UNIVERSAL

008.057.005.00.02

Perfil Superior

5,8 m



TAMPA PLAST. WHITE P/ PERFIL INF. 5003/5004

104.022.005.00.02

Tampa Inf.

100 unid

Usar com: PERFIL INF. ALUM. WHITE P/ CELULAR 5003



BOTAO PLAST. TRANSP. P/ 5003/5004

104.026.000.00.02

Botão

1000 unid

Usar com: PERFIL INF. ALUM. WHITE P/ CELULAR 5003



REGUA 22.5mm P/ 5003 E 5004

101.059.000.00.02

Régua

150 m

Usar com: PERFIL SUP. ALUM. WHITE P/ CELULAR 5003 p/ prender o tecido



CONTRA PESO DA BASE P/ PLISSADA

105.009.000.00.00

13 X 5 X 20cm

10 unid

Usar com: PERFIL INF. ALUM. WHITE P/ CELULAR 5003

Cordas e Acessórios

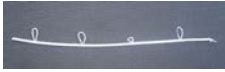

CORDA LOOP 1,5

020.007.COR.00.45

Corda

1.000 m

Usar p/ fixar o tecido no Perfil Superior



CORDA 0,9mm

025.001.COR.09.45

Várias cores

1.000 m

Usar com: MANCAL C/ ROLETE EIXO HEX. 4.5mm P/ PLISSADA CT



CABO DE ACO S/ REVESTIMENTO PLASTICO 140lbs

105.110.000.00.00

Cabo

10 m

Usar com: FIXADOR PISO L CRUDE P/ CABO DE ACO PH



FIXADOR PISO L CRUDE P/ CABO DE ACO PH

105.012.006.00.00

Tensor

10 unid

Usar p/ fixar o tecido no Perfil Superior

Ferramental para Produção



FURADEIRA TECIDO 200W 50/60HZ 220V P/ CELULAR E PLISSADA

049.200.000.00.80

Disponibilidade sob consulta



MÁQUINA CORTE TECIDO 50W 50/60HZ 220V P/ CELULAR E PLISSADA

049.100.001.00.80

Disponibilidade sob consulta