

## Romana Motorizada Large

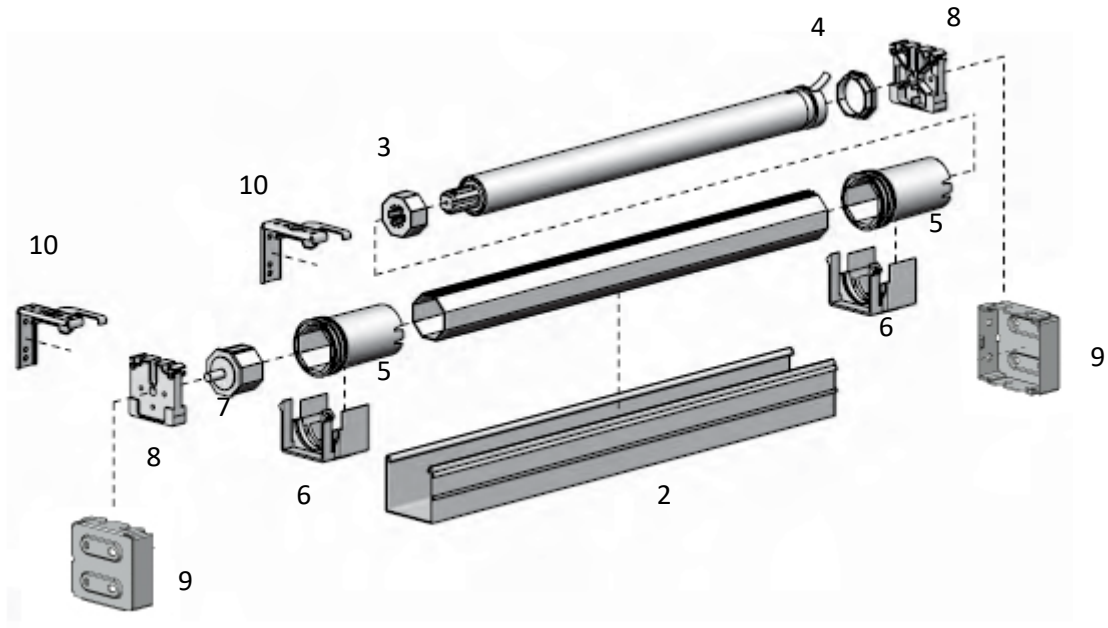

<b>1</b>		<b>TUBO ALUM. CRUDE OCTOGONAL LISO 40mm P/ MOTORIZACAO</b> 008.200.014.40.00	40 mm	6 m
<b>2</b>		<b>PERFIL SUP. LISO</b> 009.000.COR.00.07 008.001.COR.50.00	58 x 50mm – Aço 56 x 50mm – Alum.	5 m 6 m
<b>3</b>		<b>ADAPTADOR DRIVE P/ TUBO OCT. 40mm</b> 160.004.020.00.00 150.004.001.00.00	Somfy Tube	1 unid 1 unid
Usar com: TUBO ALUM. CRU OCTOGONAL LISO 40mm P/ MOTORIZACAO				
<b>4</b>		<b>ADAPTADOR COROA P/ TUBO OCT 40mm</b> 160.004.019.00.00 150.004.013.00.00	Somfy Tube	1 unid 1 unid
Usar com: Motor 35mm				
<b>5</b>		<b>CONE P/ MOTORIZACAO PH50</b> 160.004.021.00.00	Cone	1 unid
Usar com: TUBO ALUM. CRU OCTOGONAL LISO 40mm P/ MOTORIZACAO				

6		SUPORTE PLAST. BLACK P/ CONE MOTORIZACAO PH50	160.002.007.00.00	Suporte	1 unid	Usar com: PERFIL SUP. LISO
7		PONTA OPOSTA P/ TUBO OCT. 40mm	160.004.018.00.00	Ponta Oposta	1 unid	Usar com: SUPORTE P/ MOTOR E PONTEIRA P/ CTS 40
8		SUPORTE QUAD. BLACK P/ MOTOR/PONTA OPOSTA PH50	160.002.009.00.00	Suporte	1 unid	Usar com: PERFIL SUP. LISO
9		SUPORTE INSTAL. LATERAL PH50	027.021.COR.00.25	Suporte	1 jogo	Usar com: PERFIL SUP. LISO
10		SUPORTE INSTAL. L CRUDE C/ GARRA P/ PH50	104.050.000.00.00	Suporte	1 unid	Usar com: PERFIL SUP. LISO
10		SUPORTE INSTAL. L PAREDE CRUDE P/ PH50	027.022.001.00.00	Suporte	50 unid	Usar com: PERFIL SUP. LISO
10		SUPORTE INSTAL. RETO TETO CRUDE P/ PH50	027.022.000.00.01	Suporte	300 unid	Usar com: PERFIL SUP. LISO

CORRENTES, CORDAS E ACESSÓRIOS – Ver opções na página 117

PERFIL INFERIOR (BASE) – Ver opções na página nº 82

PERFIL VARETEIRO – Ver opções na página 118

---

**Motores Somfy 40mm**

Consulte a linha completa de Motores Somfy na página nº 181  
*Dê preferência a motores lentos (< 20 RPM)*

---

**Emissores Somfy**

Consulte a linha completa de Emissores Somfy na página nº 192

---

**Motores Tube 35mm**

Consulte a linha completa de Motores Tube na página nº 194  
*Dê preferência a motores lentos (< 20 RPM)*

---

**Emissores Tube**

Consulte a linha completa de Emissores Tube na página nº 197

## Perfil Inferior (Base)

Sistema / Modelo	GAP	Redondo	Slim	Reforçado	Maxi screen	New Sheer	Magic Light	Seychelles
32 mm	X	X						
38 mm	X	X	X					
41 mm	X	X	X					
56 mm	X		X	X				
66 mm			X	X	X			
85 mm				X	X			
Maxiscreen					X			
Seychelles	X							X
Slat / Roman Village						X		
Magic Light (Double Vision)						X	X	
Magic Light BK (Double Vision BK)						X		
Romana 6004	X	X	X					
Romana 6005	X	X	X					
Romana Motorizada Small	X	X						
Romana Motorizada Large	X		X	X				
Romana Skylight			X					

### GAP

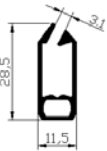

PERFIL ALUM. INF. GAP WHITE P/ ROLO (0,275 Kg/m)

008.061.005.00.00

White

6 m



LAMINA ALUM. 15 x 0,21mm

010.020.771.15.01

Fixação do tecido

1.000 m



FITA PLAST. PRETA 13mm

106.066.000.13.00

Fixação do tecido

100 m







TAMPA PLAST. WHITE P/ PERFIL INF. GAP

106.002.005.00.23





White

20 unid

**Redondo**

	PERFIL INF. ALUM. RDO. P/ ROLO (0,211 Kg/m)		
	008.017.005.00.00	White	6 m
	008.017.233.00.00	Black	6 m
<hr/>			
	LAMINA ALUM. 15 x 0,21mm		
	010.020.771.15.01	Fixação do tecido	1.000 m
	Usar com: PERFIL INF. ALUM. RDO. P/ ROLO		
<hr/>			
	FITA PLAST. PRETA 13mm		
	106.066.000.13.00	Fixação do tecido	100 m
<hr/>			
	TAMPA PLAST. WHITE P/ PERFIL INF. RDO.		
	106.001.005.00.23	White	20 unid
	106.001.233.00.23	Black	20 unid
	Usar com: PERFIL INF. ALUM. RDO. P/ ROLO		

**Slim**

	PERFIL ALUM. INF. SLIM WHITE P/ ROLO		
	008.021.005.00.09	0,404 Kg/m	5,8 m
<hr/>			
	FITA PVC INCOLOR MAGIC LIGHT		
	106.064.000.70.23	7 mm	100 m
	Para prender o tecido à base		
<hr/>			
	TAMPA PERFIL INF. SLIM WHITE		
	050.020.005.00.23	Tampa	20 unid
	Usar com: PERFIL ALUM. INF. SLIM WHITE		
<hr/>			
	ESCOVA DE VEDAÇÃO		
	050.002.233.05.00	5 x 8 mm	20 m
	050.002.233.06.00	6 x 8 mm	20 m

**Reforçado**

**PERFIL ALUM. INF. ALTO AC WHITE**

008.054.005.00.00      Alto      5,8 m

**LAMINA ALUM. 15 x 0,21mm**

010.020.771.15.01      Fixação do tecido      1.000 m

**FITA PLAST. PRETA 13mm**

106.066.000.13.00      Fixação do tecido      100 m

**TAMPA PLAST. WHITE P/ PERFIL INF. ALTO**

106.089.005.00.00      Tampa      20 unid

Usar com: PERFIL ALUM. INF. ALTO ACMEDA WHITE

**ESCOVA DE VEDAÇÃO**

050.002.233.05.00      5 x 8 mm      20 m

050.002.233.06.00      6 x 8 mm      20 m

**Maxiscreen**

**BARRA INF. ALUM. WHITE P/ MAXISCREEN**

114.006.041.50.77      Perfil Inferior      5 m

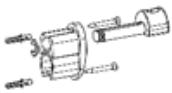
**TAMPA PLAST. C/ GUIA WHITE P/ BARRA INF. MAXISCREEN**

019.006.021.01.77      Tampa      1 Par

Usar com: BARRA INF. ALUM. WHITE P/ MAXISCREEN

**TAMPA PLAST. S/ GUIA WHITE P/ BARRA INF. MAXISCREEN**

019.006.021.00.77      Tampa      1 jogo

Usar com: BARRA INF. ALUM. WHITE P/ MAXISCREEN

**BAGUETE WHITE 5,80mm P/ TOLDO**

115.006.041.00.77      Baguete      250 m

Usar com: BARRA INF. ALUM. WHITE e TUBO ACO GALV. CRUDE 70mm P/ TOLDO

---

**BARRA GALV. CONTRAPESO 20x1,50mm P/ MAXISCREEN**

115.006.044.00.77

Contra-peso

6 m

Usar com: BARRA INF. ALUM. WHITE P/ MAXISCREEN

**New Sheer**



---

**PERFIL INF. ALUM. EXTERNO WHITE P/ NEW SHEER**

008.020.005.05.00

Externo

6 m



---

**PERFIL INF. ALUM. INTERNO OCO WHITE P/ NEW SHEER**

008.052.005.05.00

Interno

6 m



---

**TAMPA PLAST. WHITE P/ PERFIL INF. EXTERNO NEW SHEER**

019.003.000.00.64

Tampa Externa

10 jogos

Usar com PERFIL INF. ALUM. EXTERNO OCO WHITE P/ NEW SHEER



---

**TAMPA PLAST. WHITE P/ PERFIL INF. INTERNO NEW SHEER**

019.004.000.00.64

Tampa Interna

10 jogos

Usar com PERFIL INF. ALUM. INTERNO OCO WHITE P/ NEW SHEER

**Magic Light**



---

**PERFIL ALUM. INF WHITE P/ MAGIC**

008.040.005.00.00

Perfil

6 m



---

**PERFIL ALUM. INF. WHITE P/ GIRO P/ MAGIC**

008.041.005.00.00

Perfil Giro

6 m



---

**TAMPA PERFIL INF. WHITE P/ MAGIC**

106.045.005.00.23

Baixa

50 jogos

106.050.005.00.23

Alta

50 jogos

Tampa Alta: ideal para tecidos mais espessos, como Sheer BK e Allegro

**Seychelles**

**PERFIL ALUM. INF. C P/ SEY**

008.005.005.00.09

Perfil

6 m

Usar com: PERFIL ALUM. WHITE C/ PESO P/ SEYCHELLES

**PERFIL ALUM. WHITE C/ PESO P/ SEY**

008.060.005.00.09

Perfil

6 m

Usar com: PERFIL ALUM. INF. C P/ SEYCHELLES

**TAMPA PERFIL INF. P/ SEYCHELLES**

019.200.005.00.23

Tampa

100 unid

Usar com: PERFIL ALUM. INF. C P/ SEYCHELLES e PERFIL ALUM. INF. T P/ SEYCHELLES

**FITA PVC INCOLOR 45mm P/ PERFIL INF. C P/ SEY**

106.065.000.45.23

Tampa

100 m

Usar com: PERFIL ALUM. INF. C P/ SEYCHELLES e PERFIL ALUM. INF. T P/ SEYCHELLES



## Correntes e Demais Acessórios



### CORRENTE BOLA 10 DUPLA 4,5X6mm

014.004.005.10.01	White	200 m
014.004.233.10.23	Black	200 m

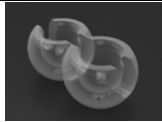

### LIMITADOR CONECTOR PLAST. TRANSP. P/ CORRENTE

014.020.000.00.23	Plástico (PVC)	500 pc
-------------------	----------------	--------

Usar com: CORRENTE BOLA 10 DUPLA PLÁSTICO 4,5X6mm



### CONECTOR PLAST. P/ CORRENTE TUB.

100.124.005.00.23	White	500 pc
100.124.233.00.23	Black	500 pc

Usar com: CORRENTE BOLA 10 DUPLA PLÁSTICO 4,5X6mm



### LIMITADOR BOLA P/ CORRENTE 10

014.018.000.00.23	Incolor	500 pc
014.018.233.00.23	Black	500 pc

Usar com: CORRENTE BOLA 10 DUPLA PLÁSTICO 4,5X6mm



### FITA DUPLA - FACE TECIDO

044.071.000.00.00	8 mm	30 m
043.036.000.00.00	12mm	50 m
044.092.000.00.00	25 mm	30 m



### ESCOVA DE VEDAÇÃO

050.002.233.05.00	5 x 8 mm	20 m
050.002.233.06.00	6 x 8 mm	20 m