

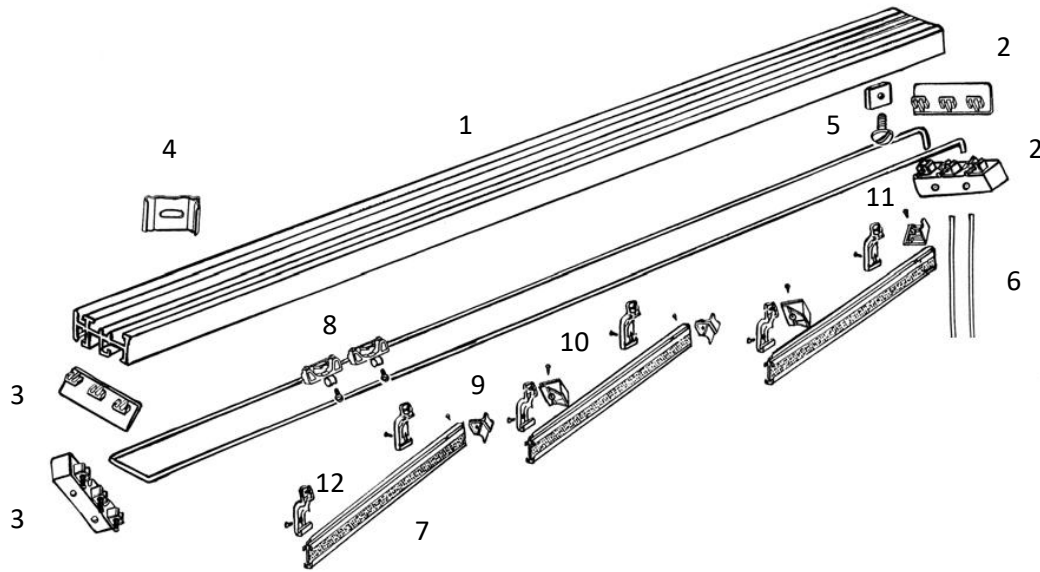

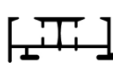

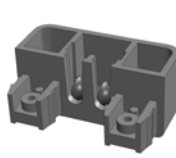

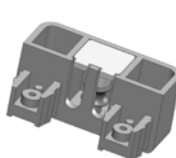

Painel Standard



| | | | |
|---|--|--------|---------|
| 1  | PERFIL SUP. ALUM. WHITE P/ PAINEL | | |
| | 008.027.005.00.00 | 2 Vias | 6 m |
| | 008.028.005.00.00 | 3 Vias | 6 m |
| | 008.029.005.00.00 | 4 Vias | 6 m |
| | 008.030.005.00.00 | 5 Vias | 6 m |
| 2  | TAMPA PLAST. WHITE P/ PAINEL | | |
| | 112.011.000.00.23 | 2 Vias | 50 unid |
| | 112.012.000.00.23 | 3 Vias | 50 unid |
| | 112.013.000.00.23 | 4 Vias | 50 unid |
| | 112.014.000.00.23 | 5 Vias | 50 unid |
| Usar com: PERFIL ALUM. WHITE P/ PAINEL | | | |
| 3  | TAMPA OPOSTA | | |
| | 112.011.001.00.23 | 2 Vias | 50 unid |
| | 112.012.001.00.23 | 3 Vias | 50 unid |
| | 112.013.001.00.23 | 4 Vias | 50 unid |
| | 112.014.001.00.23 | 5 Vias | 50 unid |
| Usar com: PERFIL ALUM. WHITE P/ PAINEL | | | |

| | | | | |
|----|---|---|-------------------|---|
| 4 |  | GARRA 2 E 3 VIAS P/ PAINEL 112.017.000.00.23 | Garra | 100 unid Usar com: PERFIL ALUM. WHITE P/ PAINEL |
| 4 |  | GARRA METAL CRUDE P/ PAINEL 4 VIAS 112.016.000.00.23 | Garra | 100 unid Usar com: PERFIL ALUM. 4 VIAS WHITE P/ PAINEL |
| 4 |  | GARRA METAL CRUDE P/ PAINEL 5 VIAS 112.015.000.00.23 | Garra | 100 unid Usar com: PERFIL ALUM. 5 VIAS WHITE P/ PAINEL |
| 5 |  | PARAFUSO C/ PORCA QUADRADO P/ PAINEL 029.017.000.00.00 | Parafuso c/ porca | 100 unid Usar com: PERFIL ALUM. WHITE P/ PAINEL |
| 6 |  | CORDA TRANÇADA 2,00mm 025.006.COR.20.00 | Corda Trançada | 500 m |
| 7 |  | PERFIL SUP. ALUM. DESLIZANTE WHITE P/ PAINEL 008.031.005.00.00 | Perfil Deslizante | 6 m |
| 8 |  | CARRO CONECTOR P/ PAINEL 112.003.000.00.23 | Conector | 100 unid Usar com: PERFIL ALUM. DESLIZANTE WHITE P/ PAINEL |
| 9 |  | SUPORTE DUPLO PLAST. WHITE P/ PAINEL 112.020.000.00.23 | Duplo | 100 unid Usar com: PERFIL ALUM. DESLIZANTE WHITE P/ PAINEL |
| 10 |  | SUPORTE SIMPLES PLAST. WHITE P/ PAINEL 112.019.000.00.23 | Simples | 100 unid Usar com: PERFIL ALUM. DESLIZANTE WHITE P/ PAINEL |
| 11 |  | SUPORTE EXTERNO PLAST. WHITE P/ PAINEL 112.021.000.00.23 | Externo | 100 unid Usar com: PERFIL ALUM. DESLIZANTE WHITE P/ PAINEL |

| | | | | | |
|---------------------------------|---|---|-------------------|---------------|----------|
| 12 |  | CARRO PLAST. DESLIZANTE P/ PAINEL | 112.022.000.00.23 | Deslizante | 100 unid |
| Usar com: CORDA TRANÇADA 2,00mm | | | | | |
| 13 |  | VELCRO MACHO/FEMEA C/ ADESIVO WHITE 18mm | 107.036.005.00.00 | Macho + Fêmea | 25 m |
| 13 |  | VELCRO C/ ADESIVO WHITE 20mm | 107.007.005.00.02 | Fêmea | 50 m |
| | | | 107.008.005.00.02 | Macho | 50 m |
| 7 |  | PERFIL ALUM. VARETEIRO 1587 WHITE P/ ROM | 008.006.005.00.00 | Vareteiro | 6 m |
| 8 |  | SUPORTE DESLIZANTE SIMPLES PLAST. TRANSP. P/ PAINEL | 112.024.000.00.23 | Simples | 100 pc |
| 9 |  | SUPORTE DESLIZANTE MONO PLAST. TRANSP. P/ PAINEL | 112.025.000.00.23 | Mono | 100 pc |
| 10 |  | SUPORTE DESLIZANTE DUPLO PLAST. TRANSP. P/ PAINEL | 112.023.000.00.23 | Duplo | 100 pc |

PERFIL INFERIOR (BASE) – Ver opções na página nº 82